

Sono



RENZ



Sono (Design: Justus Kolberg)

Die Umgebung beeinflusst unser Denken und Handeln. Sono besticht durch architektonische Qualität und kluge Funktionalität. Das Prinzip Baukasten steht hier als Gestaltungsgrundsatz, dem das vielseitige Arbeitsplatzsystem konsequent folgt. Container bilden, individuell zusammengestellt, praktische Toolboards für den Stauraum und integrieren intelligent modernste Kommunikationstechnik. Markante Aluminiumrahmen stützen Schreibtische in unterschiedlichen Tischplattenlängen, wahlweise in edlem Furnier oder aus Glas. Weitere Optionen: Runde und rechteckige Besprechungstische sowie elektromotorisch höhenverstellbare Arbeitsplätze.

Sono (Design: Justus Kolberg)

Our environment influences how we think and act. Sono's captivating features are architectural quality and clever functionality. Modularity is the basic design principle, and the multifaceted workplace system carries it out to perfection. Containers are grouped together as desired, forming practical toolboards for storage and neatly integrating the latest in modern communications technology. Striking aluminium frames support desks of various lengths in glass or fine veneer. Other options include round and rectangular conference tables as well as electrically driven height-adjustable tabletops.







Unter der Lederschiebeplatte befinden sich Ablagemöglichkeiten und Anschlüsse für elektronische Medien.

Storage space and connectors for electronic media are underneath the sliding leather top.



Unter dem Schiebetablar befindet sich eine Elektroleiste mit 3 Steckdosen und 2 RJ45-Anschlüssen.

The sliding tray covers a powerstrip with 3 sockets and 2 RJ45-sockets.

Vertikale Kabelführung am Rahmen aus eloxiertem Aluminium.

Vertical cabling at the frame made of anodized aluminum.



Die horizontale Kabelführung wird in das Profil der serienmäßigen Doppelzarge eingehängt.

The horizontal cable channel is hung in the profile of the standard-equipment double frame..

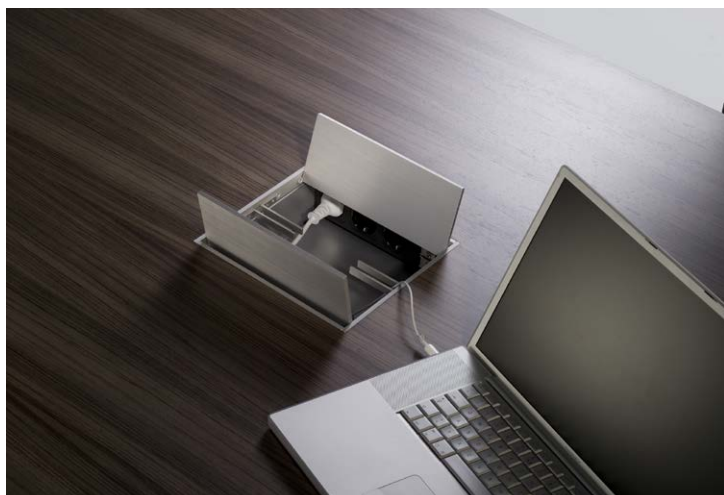

Doppel-Elektrobox aus eloxiertem Aluminium.

Double power box made of anodized aluminum.

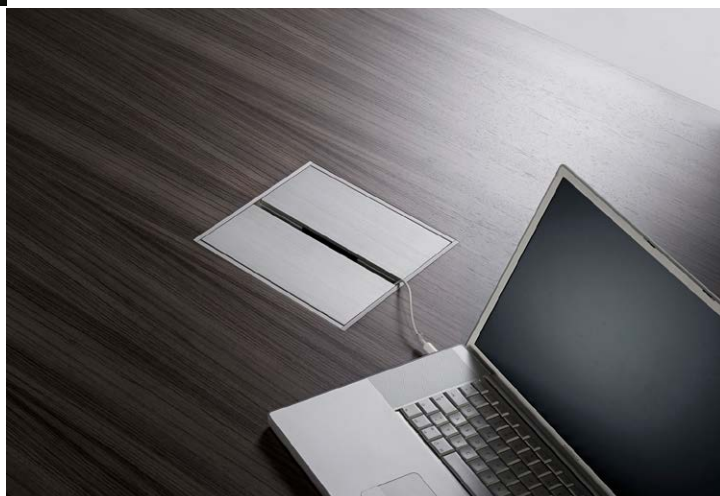

Elektromotorisch verstellbare Hubsäule.

Electromotive adjustable lifting column.

Die Rückseite des Toolboards mit Lüftungsgittern.

The backside of the toolboard with grilles for ventilation.



Sono

Maße/Dimensions

Schreibtisch mit 2 Rahmen. Desk with 2 frames.

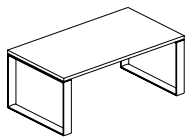

180 x 100
Höhe height 73/75

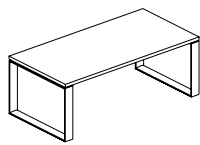

200 x 100
Höhe height 73/75

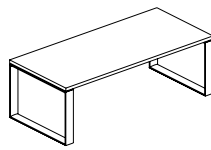

220 x 100
Höhe height 73/75

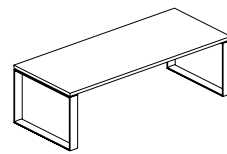

240 x 100
Höhe height 73/75

Höhenverstellbarer Schreibtisch mit 2 Säulen. Hight-adjustable desk with 2 columns.

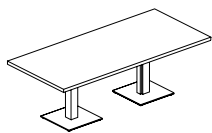

220 x 100
Höhe height 73 - 121

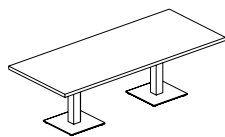

240 x 100
Höhe height 73 - 121

Schreibtischplatte* mit angebautem Toolboard. Top* with toolboard.

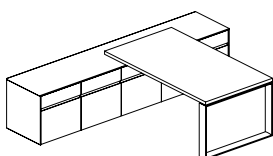

*180 x 100
Höhe height 73/75

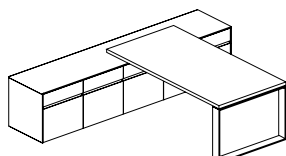

*200 x 100
Höhe height 73/75

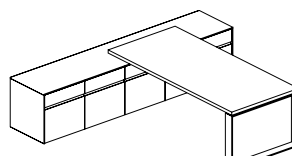

*220 x 100
Höhe height 73/75

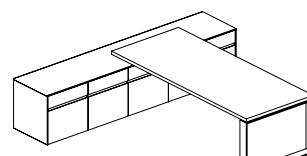

*240 x 100
Höhe height 73/75

Höhenverstellbare Schreibtischplatte* mit 2 Säulen - Eine Säule ist im Toolboard integriert.
Hight-adjustable top* with 2 columns - One column is integrated in the toolboard.

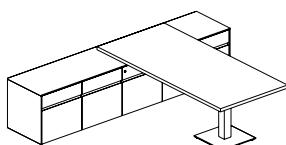

*220 x 100
Höhe height 73 - 121

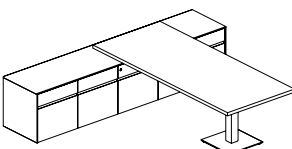

*240 x 100
Höhe height 73 - 121

Alle Maßangaben in cm. All dimensions in cm.

Container. Container.

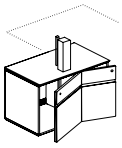

100 x 60
Höhe height 64

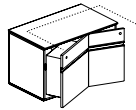

100 x 60
Höhe height 64

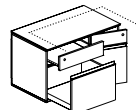

100 x 60
Höhe height 64



60 x 60
Höhe height 64



60 x 60
Höhe height 64



60 x 60
Höhe height 64



30 x 60
Höhe height 64

Abschluss-Seite. End panel.



1,2 x 60
Höhe height 64

Roll-Container. Mobile container.



62,5 x 60
Höhe height 58



62,5 x 60
Höhe height 58

Besprechungstisch. Meeting table.

für 4 Personen
for 4 people



Ø 110
Höhe height 73

für 5 Personen
for 5 people



Ø 125
Höhe height 73

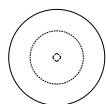

K 24

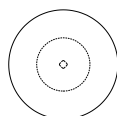

K 25

für 4 Personen
for 4 people

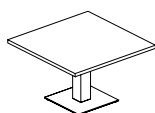

120 x 120
Höhe height 73

für 6 Personen
for 6 people

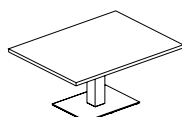

160 x 120
Höhe height 73

für 8 Personen
for 8 people

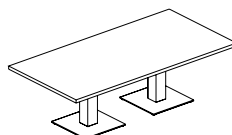

240 x 120
Höhe height 73



K 26
K 36*

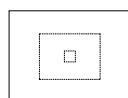

K 27

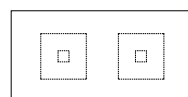

K 28
K 38*

* höhenverstellbar/adjustable in height

Beispielhafte Toobboardkonfiguration. Exemplary toolboard configuration.

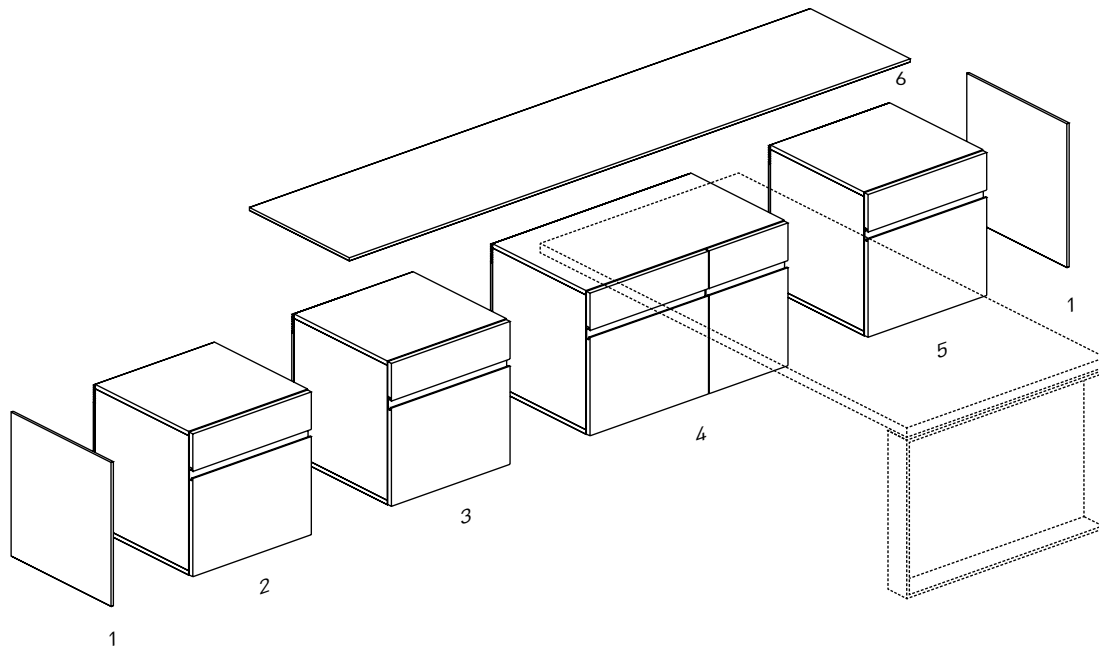

1. Abschluss-Seite. End panel. 2. Container K45 mit einer Schublade, Innenschublade und Hängeregistratur. Container K45 with one drawer, a drawer inside and a file extension. 3. Container K 46 mit einer Schublade und einer Schublade für Drucker (incl. Lüftung). Container K 46 with one drawer and one drawer for printer (with ventilation) 4. Container K 40 zur Auflage der Tischplatte mit 2 Türen und einer PC-Halterung. Container K 40 to support the desk top, with 2 doors and a PC-fitting. 5. Container K 43 mit einer Tür, bspw. für den Einbau eines Kühlschranks. Container K 43 with one door, e.g. for the Build-in fridge. 6. Abdeckplatte bis zu der Länge von 283 cm einteilig. Covering panel in a single section up to the length of 283 cm.

Beispielhafte Schreibtischkonfiguration. Exemplary desk configuration.

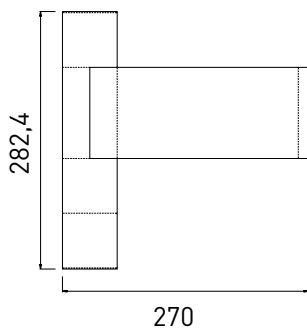

Schreibtischkonfiguration bestehend aus:

Tischplatte K11	240,0 x 100,0
Rahmen K 20	11,3 x 100,0
2 x Abschluss-Seite K49	1,2 x 60,0
Container K 45	60,0 x 60,0
Container K 46	60,0 x 60,0
Container K 40	100,0 x 60,0
Container K 43	60,0 x 60,0

Desktop configuration consisting of:

Top K11	240,0 x 100,0
Frame K 20	11,3 x 100,0
2 x End panel K49	1,2 x 60,0
Container K 45	60,0 x 60,0
Container K 46	60,0 x 60,0
Container K 40	100,0 x 60,0
Container K 43	60,0 x 60,0

Sono

Besprechungstische/Conference tables

Meeting- und Konferenztische von Sono gibt es in drei unterschiedlichen Varianten: Runde Tische, rechteckige Tische mit einer starren Säule sowie rechteckige Tische, die elektrisch variabel höhenstellbar sind. Die Säulen sind aus Aluminium eloxiert, die Bodenplatten sind alufarbig beschichtet.

Sono meeting and conference tables are available in three types: round tables, rectangular tables with a fixed base and electrically height-adjustable rectangular tables. The bases are in anodised aluminium; the floor plates are coated with aluminium colour.



K 24 | Ø 110 cm

K 25 | Ø 125 cm

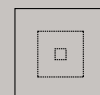

K 26 | 120 x 120 cm

K 36 | höhenverstellbar / adjustable in height



K 27 | 160 x 120 cm

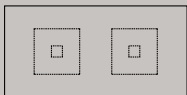

K 28 | 240 x 120 cm

K 38 | höhenverstellbar / adjustable in height

Sono

Individuelle Lösungen/Individual solutions

RENZ plant und fertigt Tische und Tischanlagen nach Ihren Vorgaben und Vorstellungen. Exklusive Sonderlösungen, individuell angepasst, in von der Serie abweichenden Maßen, Formen und Materialien. Sprechen Sie mit unseren erfahrenen und kompetenten Spezialisten oder mit den Fachleuten unserer ausgewählten Handelspartner.

RENZ designs and manufactures tables and table systems according to your wishes and specifications. Exclusive custom solutions to accommodate your unique needs can incorporate non-standard sizes, forms and materials. Talk to our competent, experienced specialists or to the experts at our selected partner firms.

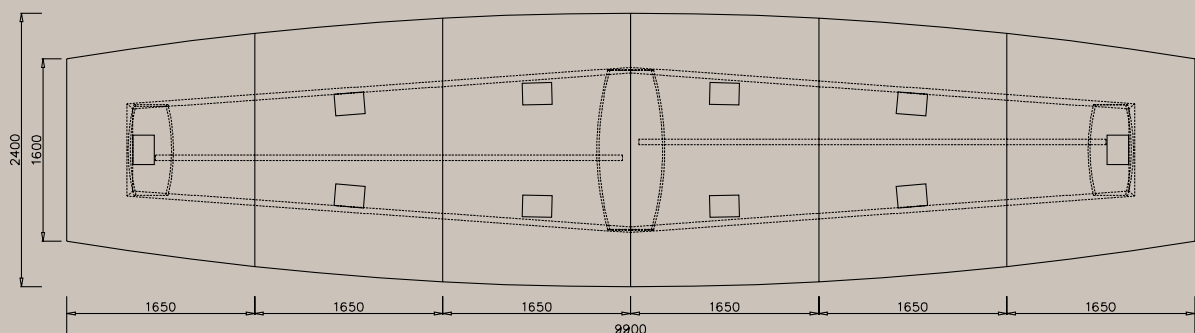
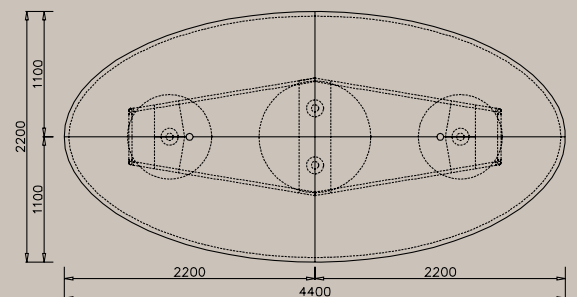
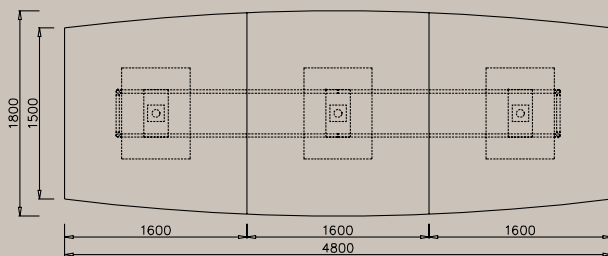
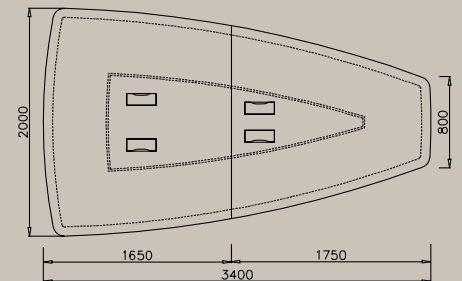
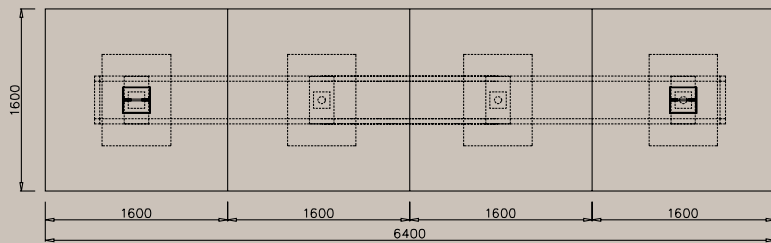



Sono

Materialien /Materials



Birnbaum natur
Pear natural



Am. Kirschbaum natur
Am. Cherry natural



Eiche matt
Oak matt



Eiche hell
Oak light



Eiche titangrau
Oak grey titan



Eiche urban grey
Oak urban grey



Eiche mocca
Oak mocca



Räuchereiche
Oak smoked



Zebrano grau
Zebrano grey



Zebrano natur
Zebrano natural



Am. Nussbaum natur
Am. Walnut natural



Nussbaum tabac
Walnut tobacco



Eiche schwarz
Oak black

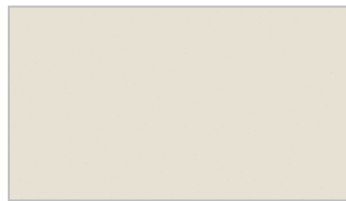

Lack Hochglanz/seidenmatt weiß
Lacquer high gloss/silk matt white

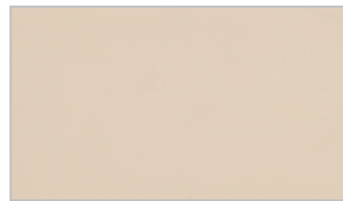

Lack Hochglanz/seidenmatt crema
Lacquer high gloss/silk matt crema



Lack Hochglanz/seidenmatt anthrazit
Lacquer high gloss/silk matt anthracite



Lack Hochglanz/seidenmatt akzentrot
Lacquer high gloss/silk matt accent red

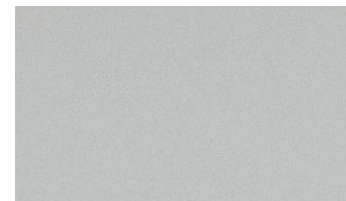

Lack alusilber
Lacquer aluminium silver

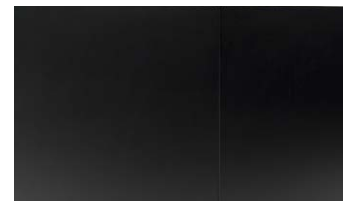

Lack schwarz metallic
Lacquer black metallic



Laminat Nano weiß
Laminate nano white



Laminat Nano stone
Laminate nano stone

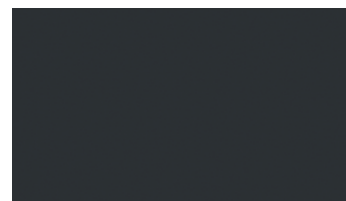

Laminat Nano schwarz
Laminate nano black

Die abgebildeten Farben sind nicht farbverbindlich. Die Darstellung kann je nach Monitor und Drucker variieren. Weitere Oberflächenausführungen wie Furniere, Laminat und Linoleum nach Muster auf Anfrage.

The colours shown are intended as a guideline only. Their representation may vary depending on the monitor and printer. Further surface finishes such as natural wood veneer, laminate and linoleum on request by sample.

Wilhelm Renz GmbH + Co. KG
Hanns-Klemm-Straße 35
71034 Böblingen
Germany

T +49 (0)7031.21880
F +49 (0)7031.218850
info@renz.de
www.renz.de

